

1/4

## ANTI-CHOCPUTTEN



### Toezichtputten in pvc anti-choc

Materiaal: polypropyleen

Gebruik: toezichtput voor regen- en afvalwater

Kleur: ral 7035

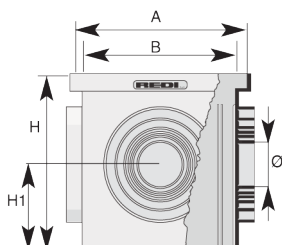

Code	Afmetingen	A	B	H	H1	Ingangen
	mm	mm	mm	mm	mm	Ø
TZP2020	200x200	189	161	200	100	75, 90, 110
TZP3030	300x300	286	253	297	140	75, 90, 110, 125, 160
TZP4040	400x400	384	355	397	200	100, 125, 140, 160, 200, 250
TZP5555	550x550	535	500	520	250	160, 200, 250, 315

### PP opzetstuk

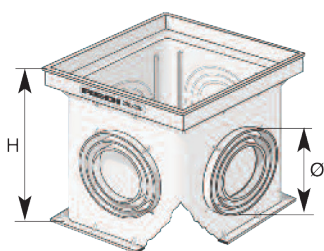

Code	Afmetingen	H	Ingangen
	mm	mm	Ø
VTZP20	200x200	200	75, 90, 110
VTZP30	300x300	297	75, 90, 110, 125, 160
VTZP40	400x400	397	100, 125, 140, 160, 200, 250
VTZP55	550x550	520	160, 200, 250, 315

Afmetingen, kleur en gewichten zijn ter indicatieve titel en onder voorbehoud van wijzigingen.

[www.deschacht.eu](http://www.deschacht.eu)

Riolering  
& Afvoer

Dak, Gevel  
& Isolatie

Folies

Oostakker | Antwerpsesteenweg 1068, 9041 Gent-Oostakker | T +32 (0)9 355 74 54 | F +32 (0)9 355 76 79 | oostakker@deschacht.eu

Aartselaar T +32 (0)3 870 69 69  
Zedelgem T +32 (0)50 27 61 11

Tielt T +32 (0)51 68 93 77  
Hamme T +32 (0)52 25 87 20

Geel T +32 (0)14 56 38 30  
Hoogstraten T +32 (0)3 340 20 60

## ANTI-CHOCPUTTEN

### PP opzetstuk

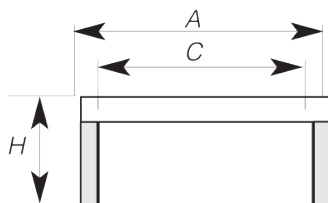

Code	Afmetingen	H	A	C
	mm	mm	mm	mm
VTZP20100	200x200	100	189	161
VTZP30100	300x300	100	286	253
VTZP40100	400x400	100	384	355
VTZP55315	550x550	315	532	500

### PP Sifflonplaten

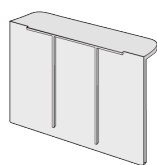

Code	Afmetingen
	mm
SFPL20	200x200
SFPL30	300x300
SFPL40	400x400
SFPL55	550x550

### PP Reukafsluiters voor basiselement

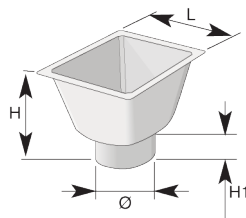

Code	Afmetingen TZP	H	H1	L	ø
	mm	mm	mm	mm	mm
RAS3030	300x300	210	58	251	125
RAS4040	400x400	300	75	350	160

Afmetingen, kleur en gewichten zijn ter indicatieve titel en onder voorbehoud van wijzigingen.

3/4

## ANTI-CHOCPUTTEN

PP Reukafsluiter voor opzetstuk

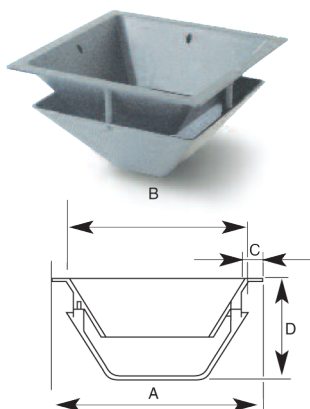

Code	Afmetingen VTZP mm	A mm	B mm	C mm	D mm
RASV3030	300x300	249	238	5	160

PVC kader

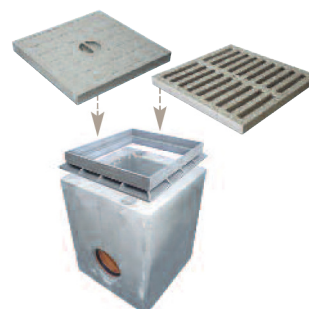
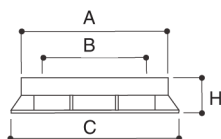

Code	Afmetingen mm	Max. Belasting kg	A mm	B mm	C mm	H mm
PAR0A20	200x200	710	200	160	209	40
PAR0A30	300x300	790	300	250	328	42
PAR0A40	400x400	960	400	350	428	45
PAR0A55	550x550	2850	550	500	583	55

Afmetingen, kleur en gewichten zijn ter indicatieve titel en onder voorbehoud van wijzigingen.

[www.deschacht.eu](http://www.deschacht.eu)

Riolering  
& Afvoer

Dak, Gevel  
& Isolatie

Folies

Oostakker | Antwerpsesteenweg 1068, 9041 Gent-Oostakker | T +32 (0)9 355 74 54 | F +32 (0)9 355 76 79 | oostakker@deschacht.eu

Aartselaar T +32 (0)3 870 69 69  
Zedelgem T +32 (0)50 27 61 11

Tielt T +32 (0)51 68 93 77  
Hamme T +32 (0)52 25 87 20

Geel T +32 (0)14 56 38 30  
Hoogstraten T +32 (0)3 340 20 60

4/4

## ANTI-CHOCPUTTEN

### Roosters apart

Materiaal: PVC

Gebruik: afsluiten van toezichtput voor regen- of afvalwater

Kleur: ral 7035

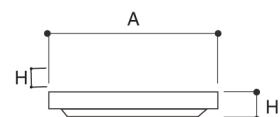

Code	Afmetingen	Max. Belasting	A	H	H1
	mm	kg	mm	mm	mm
PAROA20	200x200	710	187	20	25
PAROA30	300x300	790	284	20	30
PAROA40	400x400	960	383	25	35
PAROA55	550x550	2850	534	34	45

### Deksels apart

Materiaal: PVC

Kleur: ral 7035

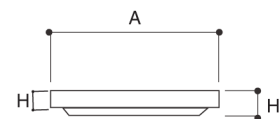
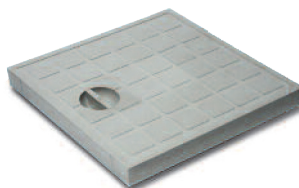

Code	Afmetingen	Max. Belasting	A	H	H1
	mm	kg	mm	mm	mm
PADEA20	200x200	840	187	20	25
PADEA30	300x300	1360	284	20	30
PADEA40	400x400	1080	383	25	35
PADEA55	550x550	3070	534	34	45

Afmetingen, kleur en gewichten zijn ter indicatieve titel en onder voorbehoud van wijzigingen.

[www.deschacht.eu](http://www.deschacht.eu)

Riolering  
& Afvoer

Dak, Gevel  
& Isolatie

Folies

Oostakker | Antwerpsesteenweg 1068, 9041 Gent-Oostakker | T +32 (0)9 355 74 54 | F +32 (0)9 355 76 79 | oostakker@deschacht.eu

Aartselaar T +32 (0)3 870 69 69  
Zedelgem T +32 (0)50 27 61 11

Tielt T +32 (0)51 68 93 77  
Hamme T +32 (0)52 25 87 20

Geel T +32 (0)14 56 38 30  
Hoogstraten T +32 (0)3 340 20 60