

Entry manholes **DIAMIR 1000**

Description

Technical features

Entry manholes **DIAMIR 1000**

Main components of a chamber

-base unit, a base of an entry manhole, allowing for direct connection of storm water drainage or sanitary sewer systems installed in the ground, including incorporated channels with possible branches along with possible branches

-shaft, a chamber built of modular PP sections, of the internal diameter 1000, equipped with access steps

-reduction cone PP 1000/600 allowing for adjustment of the manhole height. The cone is equipped with access steps



Standards:

-DIAMIR 1000 inspection chamber is compliant with

PN-EN 13598-2:2009

PN-EN 476:2011

-approval for use in road ROWs

Technical Approval **IBDIM AT/2010-02-2830**

Technical approval **IK AT/07-2011-0242-00**

Technical Approval **IBDIM AT/2011-02-2706**

-GIG (Central Mining Institute) Opinion approving their use in the areas of mining damages up to the 4th category

-Chemical resistance of chamber PP components to chemical substances is compliant with

the ISO/TR 10358 Guidelines

-Gully tops and manhole tops meet the requirements of standard

PN-EN 124:2000

-manhole steps meet the requirements of standard

PN-EN 13101:2005

-Seals meet the requirements of standard

PN-EN 681-1:2002

-Chemical resistance of elastomeric seals to chemical substances is compliant with

the ISO/TR 7620 Guidelines

Usage:

-maximum installation depth 6 m

-acceptable ground water table 5 m

-acceptable load caused by traffic SLW60 according to ATV-A127P

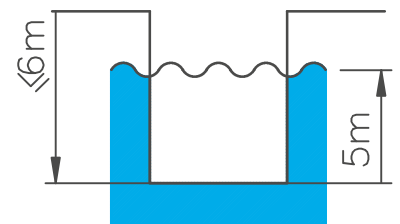

Technical features

Technical data

Base units are made of polypropylene, with reinforcing ribs. They are adapted to connection with vertical riser pipes. There is a horizontal channel in the base unit with one or a few inlet connector pipes and one outlet connector pipe ending with bells for connection with plain wall pipes made of PVC-U, PP or PE or connector pipes adapted to connection with structural pipes K2-KAN.



Type 1 0° DN	Type 1 15° DN	Type 1 30° DN	Type 1 45° DN	Type 1 90° DN	Type 2 45° 90°		
					DN 1	DN	DN 1
200	200	200	200	200	200	200	200
250	250	250	250	250	250	250	250
315	315	315	315	315	315	315	315
400	400	400	400	400	400	400	400
500	500	500	500	-	-	-	-
200K2-Kan	200K2-Kan	200K2-Kan	200K2-Kan	200K2-Kan	200K2-Kan	200K2-Kan	200K2-Kan
250K2-Kan	250K2-Kan	250K2-Kan	250K2-Kan	250K2-Kan	250K2-Kan	250K2-Kan	250K2-Kan
300K2-Kan	300K2-Kan	300K2-Kan	300K2-Kan	300K2-Kan	300K2-Kan	300K2-Kan	300K2-Kan
400K2-Kan	400K2-Kan	400K2-Kan	400K2-Kan	400K2-Kan	400K2-Kan	400K2-Kan	400K2-Kan
500K2-Kan	500K2-Kan	500K2-Kan	500K2-Kan	-	-	-	-
600K2-Kan	600K2-Kan	600K2-Kan	-	-	-	-	-

A ball-and-socket joints $\pm 7,5^\circ$ may be used in connection bells 160; 200; 250; 315 (page 28)

Height adjustment

Entry manholes DIAMIR 1000

Specifications and height adjustment

Preparing specifications for materials required for an investment, total numbers of individual inspection chamber components should be indicated:

-base units, -riser pipes, -tops

The input parameter is chamber height specified in the design – the distance between the ground level and the chamber invert (base unit level). We label it as **Hs**.

In order to make calculations easier, there is useful height (**Hu**) specified for each base unit type, that is, the distance between the bottom of a base unit and the bottom of base unit bell in which a riser pipe is installed.

For calculations, we label the height of vertical chamber sections as **Hw**. Taper height will be **Hst**. The effective height of a top section (telescope) will be **Ha**.

Entry manhole DIAMIR 1000

$$H_s = H_u + H_w + H_{st} + H_a$$

$$H_a = H_t + H_z$$

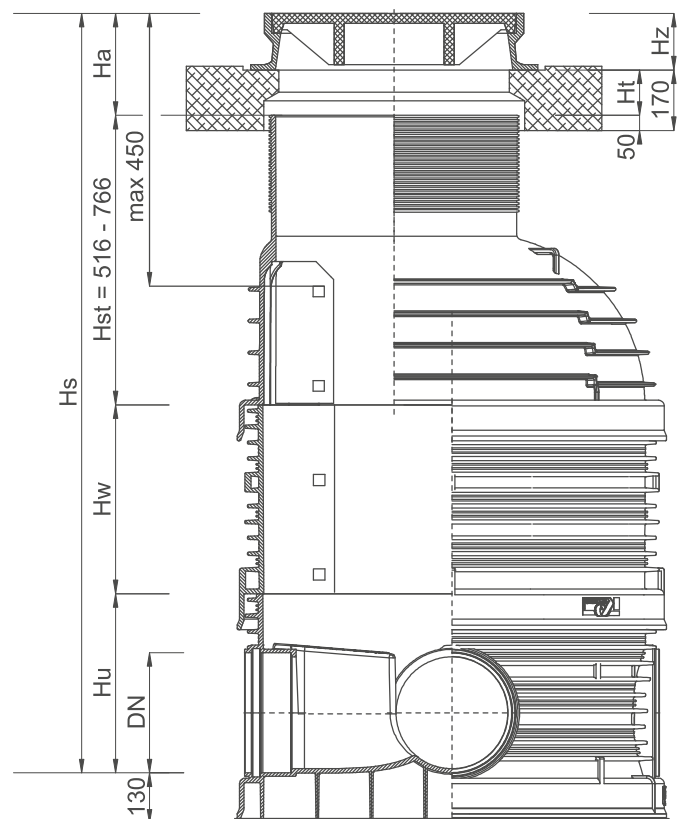

Entry manholes DIAMIR 1000

Solution options

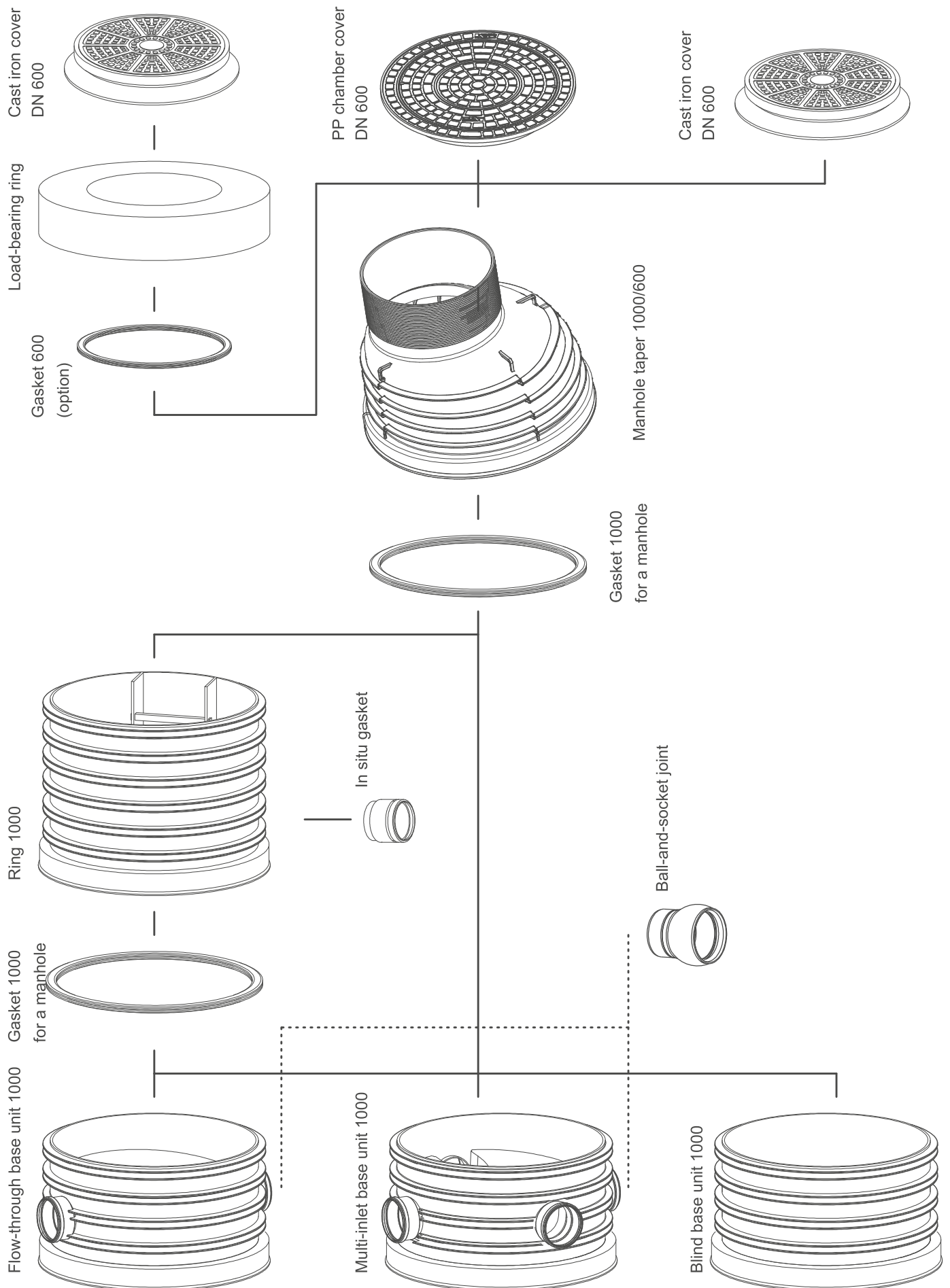

Entry manholes DIAMIR 1000

Assortment

DESCHACHT

bouw | project | partner

Flow-through base unit 1000

Type 1

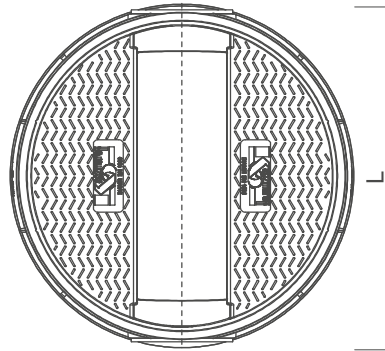
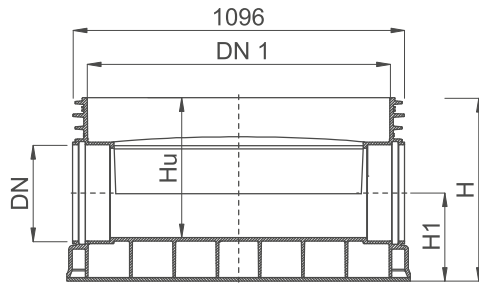

DN [mm]	DN 1 [mm]	H [mm]	Hu [mm]	H1 [mm]	L [mm]	Weight [kg]	index -
200	1000	595	444	252	1136	73,4	2631130030
250	1000	595	460	260	1136	76,4	2631140030
315	1000	595	475	280	1136	76,4	2631150030
400	1000	595	496	300	1440	91,6	2631160030
500	1000	845	665	440	1496	94,5	2631170030
200 K2 *	1000	595	438	259	1230	73,4	2631530030
250 K2 *	1000	595	432	291	1272	76,4	2631540030
300 K2 *	1000	595	435	320	1320	76,4	2631550030
400 K2 *	1000	595	495	382	1430	93,1	2631560030
500 K2 *	1000	845	658	440	1516	94,8	2631570030
600 K2 *	1000	845	665	498	1576	123,5	2631580030

* no gaskets in connection bells

Flow-through base unit 1000

Type 1

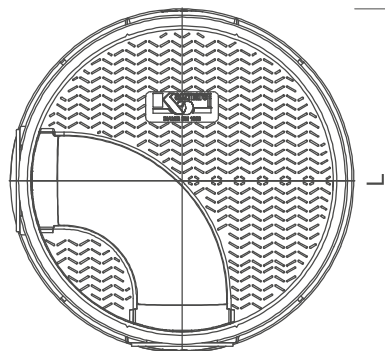
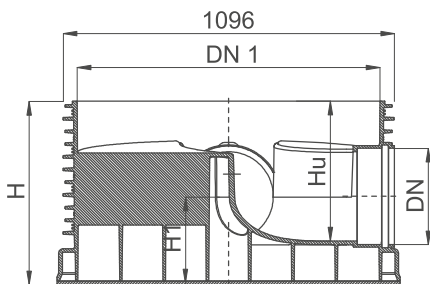

DN [mm]	DN 1 [mm]	H [mm]	Hu [mm]	H1 [mm]	L [mm]	Weight [kg]	index -
200x90°	1000	595	444	252	1136	73,8	2631139030
250x90°	1000	595	460	260	1136	76,8	2631149030
315x90°	1000	595	475	280	1136	76,4	2631159030
400x90°	1000	595	496	300	1440	91,6	2631169030
200K2-90° *	1000	595	444	252	1136	52,2	2631539030
250K2-90° *	1000	595	460	260	1136	55,0	2631549030
300K2-90° *	1000	595	475	280	1136	57,5	2631559030
400K2-90° *	1000	595	496	300	1440	91,6	2631569030

* no gaskets in connection bells

Entry manholes DIAMIR 1000

Assortment

Flow-through base unit 1000

Type 1

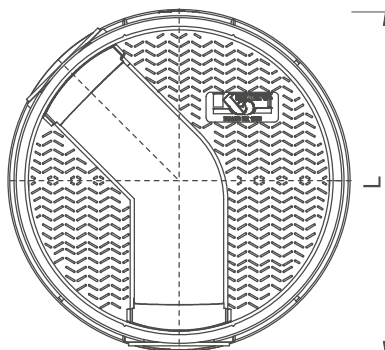
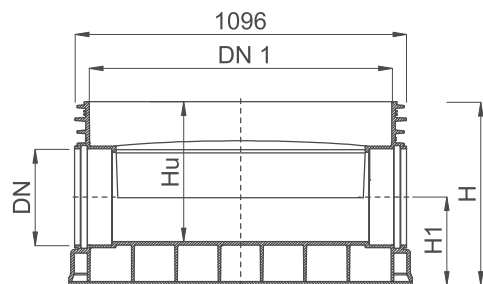

DN [mm]	DN 1 [mm]	H [mm]	Hu [mm]	H1 [mm]	L [mm]	Weight [kg]	index -
200x15°	1000	595	444	252	1136	73,8	2631131530
250x15°	1000	595	460	260	1136	76,8	2631141530
315x15°	1000	595	475	280	1136	76,4	2631151530
400x15°	1000	595	496	300	1440	91,6	2631161530
500x15°	1000	845	665	440	1496	94,5	2631161530
200K2-15°*	1000	595	444	252	1136	52,2	2631531530
250K2-15°*	1000	595	460	260	1136	55,0	2631541530
300K2-15°*	1000	595	475	280	1136	57,5	2631551530
400K2-15°*	1000	595	496	300	1440	91,6	2631561530
500K2-15°*	1000	845	658	440	1430	94,8	2631561530
600K2-15°*	1000	845	665	498	1516	123,5	2631561530
200x30°	1000	595	444	252	1136	73,8	2631133030
250x30°	1000	595	460	260	1136	76,8	2631143030
315x30°	1000	595	475	280	1136	76,4	2631153030
400x30°	1000	595	496	300	1440	91,6	2631163030
500x30°	1000	845	665	440	1496	94,5	2631163030
200K2-30°*	1000	595	444	252	1136	52,2	2631533030
250K2-30°*	1000	595	460	260	1136	55,0	2631543030
300K2-30°*	1000	595	475	280	1136	57,5	2631553030
400K2-30°*	1000	595	496	300	1440	91,6	2631563030
500K2-30°*	1000	845	658	440	1430	94,8	2631563030
600K2-30°*	1000	845	665	498	1516	123,5	2631563030
200x45°	1000	595	444	252	1136	73,8	2631134530
250x45°	1000	595	460	260	1136	76,8	2631144530
315x45°	1000	595	475	280	1136	76,4	2631154530
400x45°	1000	595	496	300	1440	91,6	2631164530
500x45°	1000	845	665	440	1496	94,5	2631164530
200K2-45°*	1000	595	444	252	1136	52,2	2631534530
250K2-45°*	1000	595	460	260	1136	55,0	2631544530
300K2-45°*	1000	595	475	280	1136	57,5	2631554530
400K2-45°*	1000	595	496	300	1440	91,6	2631564530
500K2-45°*	1000	845	658	440	1430	94,8	2631564530

* no gaskets in connection bells

Entry manholes DIAMIR 1000

Assortment

DESCHACHT

bouw | project | partner

Multi-inlet base unit 1000

Type 2

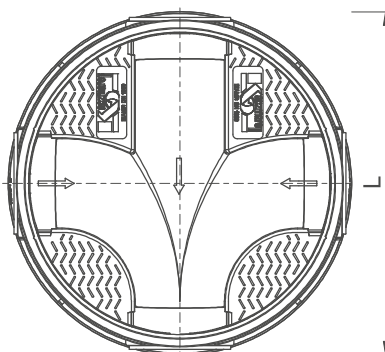
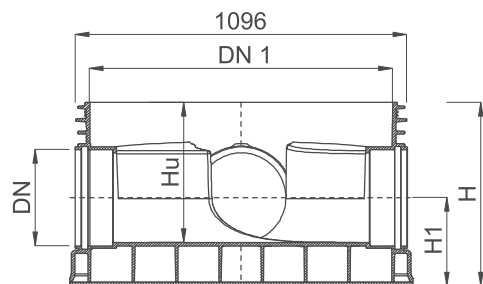

DN [mm]	DN 1 [mm]	H [mm]	Hu [mm]	H1 [mm]	L [mm]	Weight [kg]	index -
200	1000	595	444	252	1136	52,9	2632139030
250	1000	595	460	260	1136	56,3	2632149030
315	1000	595	475	280	1136	59,3	2632159030
400	1000	595	496	300	1440	95,6	2632169030
500	1000	845	705	440	1496	101,3	2632179030
200 K2 *	1000	595	438	259	1230	53,3	2632539030
250 K2 *	1000	595	432	291	1272	57,1	2632549030
300 K2 *	1000	595	435	320	1320	60,2	2632559030
400 K2 *	1000	595	495	382	1430	97,7	2632569030
500 K2 *	1000	845	705	440	1516	103,4	2632579030

* no gaskets in connection bells

Blind base unit 1000

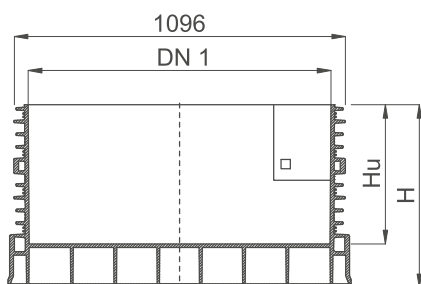

DN 1 [mm]	H [mm]	Hu [mm]	Weight [kg]	index -
1000	595	480	66,0	2630040030
1000	1095	980	82,5	2630080030

Entry manholes DIAMIR 1000

Assortment

DESCHACHT

bouw | project | partner

Ring 1000

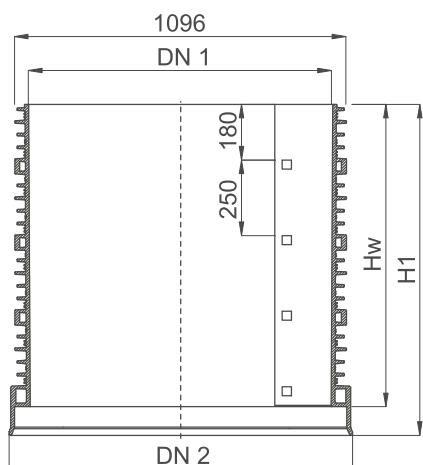

Hw [mm]	H1 [mm]	DN 1 [mm]	DN 2 [mm]	Weight [kg]	index -
250	345	1000	1136	21,0	2639120030
500	595	1000	1136	36,0	2639140030
750	845	1000	1136	52,5	2639160030
1000	1095	1000	1136	68,0	2639180030

Manhole gasket 1000

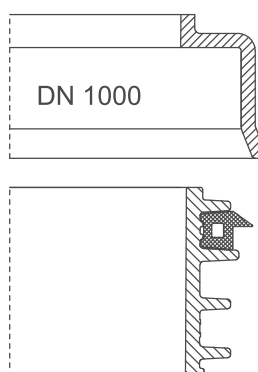
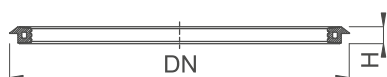

DN [mm]	H [mm]	Weight [kg]	index -
1000	30	3,8	5161231010

Manhole taper 1000

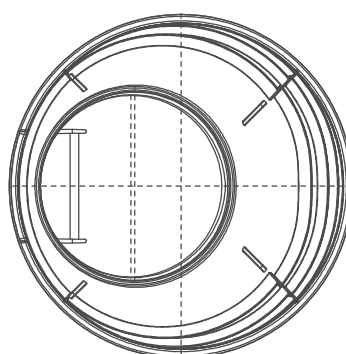
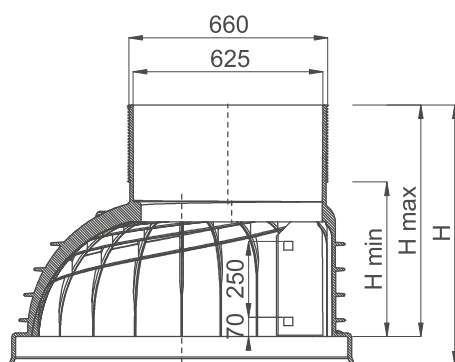

DN [mm]	DN 2 [mm]	H min [mm]	H max [mm]	H [mm]	Weight [kg]	index -
1000/625	1100	516	766	861	43,0	2639220030

Entry manholes DIAMIR 1000

Assortment

DESCHACHT

bouw | project | partner

Manhole gasket 1000/600 for a manhole taper



Load-bearing ring

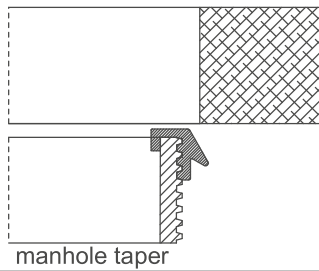

DN [mm]	H [mm]	Weight [kg]	index -
1000	30	2,1	5164181010

Load-bearing ring

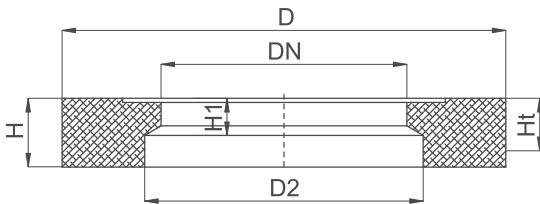

DN [mm]	D [mm]	D2 [mm]	H [mm]	H1 [mm]	Ht [mm]	Weight [kg]	index -
600	1100	690	170	90	120	220,0	2953184000

PP chamber cover DN 600

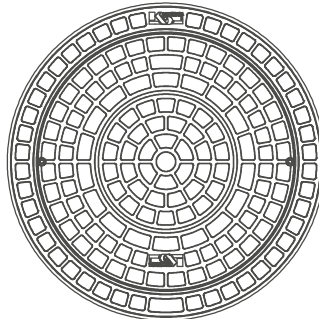
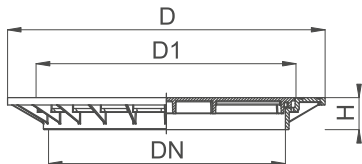

	DN [mm]	D [mm]	D1 [mm]	H [mm]	Weight [kg]	index -
A15	600	800	650	80	8,4	2589421090

Cast iron chamber cover DN 600

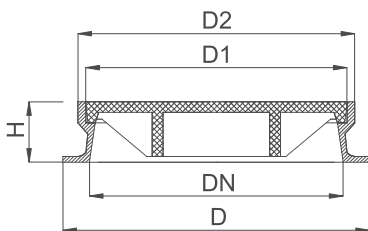

	DN [mm]	DN 1 [mm]	D1 [mm]	D2 [mm]	H [mm]	Weight [kg]	index -
A15	600	680	630	670	50	35,9	2901281500
B125	600	750	640	680	150	103,5	2901282500
C250	600	750	640	680	150	112,0	2901283500
D400	600	760	640	680	150	145,0	2901284500
D400 Gully grating	600	750	680	710	100	119,0	2902284500

Installation instructions

DIAMIR inspection chambers should be installed in conditions specified in the technical design. The ground around chambers (0,3 m) should be composed of compactable soil, approved for use in road construction according to standard PN-S-02205:1998. Earthworks should be carried out in accordance with standard PN-EN 1610:2002/Ap1:2007. Soil compaction should be performed in layers as specified in standard PN-ENV 1046:2007 to prevent from excessive ovalisation of a chamber cross-section.



1 Prepare a trench in an inspection chamber location removing large and sharp-edged stones. On the trench bottom prepare bedding composed of compactable soil, preferably sand (coarse- medium- or fine-grained) of minimum 10 cm thickness. An inspection chamber zone should include an area of at least a 30 cm wide strip around the chamber.



2 Place a base unit on a prepared earlier sand bedding and level it and then connect sewage pipes to the chamber. A place where a manhole is located should be lowered by approximately 10 cm. Connect sewage pipes.



3 Fill up the trench with preliminary backfill (10 cm above the pipe level). Compaction should be performed manually, in layers every 15 cm or with light mechanical equipment (each layer up to 30 cm). Base unit 1000 should protrude above the backfill level.

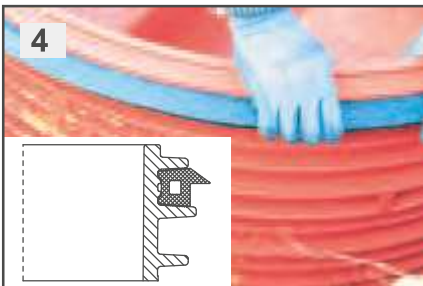

4 Install a gasket $\varnothing 1000$ in the lowest groove on the outside of the ring. The groove should be thoroughly cleaned before gasket installation.



5 Lubricant should be applied onto a gasket $\varnothing 1000$ before jointing with another manhole section. Products approved for rubber gaskets and plastic should be used. Note! If there are no rings of diversified heights on a building site, rings of standard heights may be cut. Rings may be cut only at marked places every 25 cm.

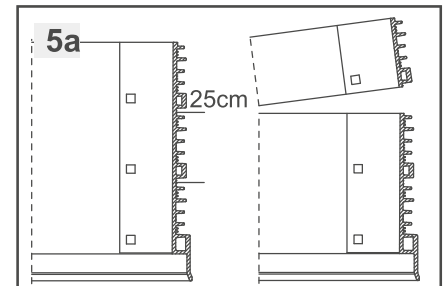

6 A taper should be installed similarly to other manhole components (rings $\varnothing 1000$). A cylindrical section of the taper (from the minimum of 1 to the maximum of 25 cm) may be cut to achieve the required manhole height.

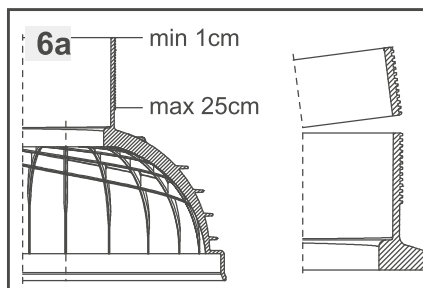

Note! A gasket may be installed in the cylindrical taper section (between the taper and a concrete ring).



7 For shallow installations, taper 1000/600 may be connected directly to a base unit with no ring used.

Installation instructions



Compact the area around the pipe. Compaction should be performed manually, in layers every 15 cm or with light mechanical equipment (each layer up to 30 cm) in open areas to at least 90% of the Proctor compaction test and for inspection chambers located in a carriageway or road shoulder backfill should meet the requirements specified for compaction index resulting from the installation depth, road construction type (cutting, embankment) or traffic intensity category.

The manhole cover should be secured against shifting by means of anchoring or concreting.

Manhole tops

Location of a DIAMIR 1000 manhole and expected load caused by traffic are the basis for selection of riser and telescope pipe stiffness and a choice of cast iron covers.

Depending on the chamber location within a ROW and a traffic intensity category, different manhole/gully tops are used, also construction requirements and top type which are classified into the following groups may differ.

Group 1 - Class A15 - green areas intended solely for pedestrians and pedal cyclists

Group 2 - Class B125 - Roads and areas for pedestrians, and comparable areas, parking lots or places where cars are parked

Group 3 - Class C250 - Applies solely do sewer gully tops installed in the area of kerbside channels of roads and road shoulders

Group 4 - Class D400 - Carriageways of roads (including pedestrian streets) hard shoulders, and parking areas for all types of road vehicles

There are different rules of the manhole/gully top support depending on their type and class, and soil conditions. A manhole/gully top should sit on a reinforced concrete slab which is supported by an appropriately constructed load bearing structure adapted to loads caused by traffic. That may be reinforced bedding made of well compacted soil or a precast load-relieving slab made of reinforced concrete. For very heavy load caused by traffic or doubts about compaction of soil constituting the top base, a slab should be based on B30 concrete ring of minimum height of 20 cm cast on a building site

PP chamber cover DN 600

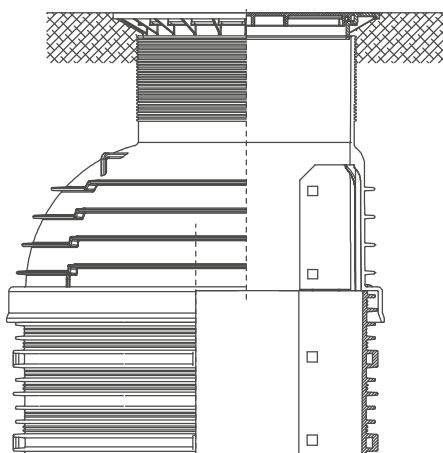

Cast iron cover DN 600

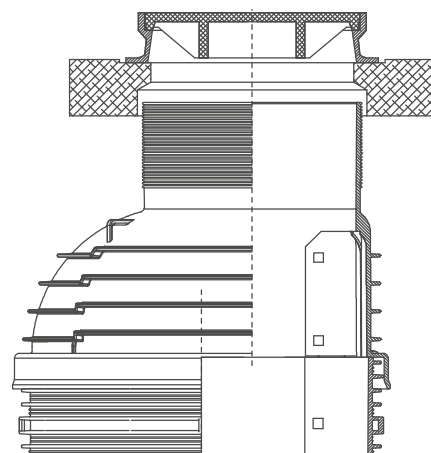

Backdrop manholes

Sometimes it is necessary to connect a channel to a manhole above a base unit.

Then, a so called backdrop manhole is constructed. According to standard PN-B-10729 “backdrop manholes in channels of diameters up to 0,40 m and drop height from 0,5 - 4,0 m may be constructed with a backdrop pipe placed inside or outside of a manhole. In a non-entry inspection chamber a drop pipe may be not installed.

That means that for non-entry inspection chambers, if a channel diameter does not exceed 160 mm, connection may be made through a hole in a riser pipe.

Appropriate in-situ gaskets are installed in the hole. If a channel is a K2-Kan structured pipe, a special fitting (adapter to a PVC socket) should be inserted into the in-situ gasket. A backdrop pipe is not used. However, if a channel diameter exceeds 200 mm, a backdrop pipe has to be used and it should be connected to a chamber base unit. A T-branch connection is fitted to the channel. One of T-connections is connected to the backdrop pipe and the second (after diameter reduction to 60 mm) is connected to a riser pipe (hole with an in-situ gasket).

