

Rabat 150  
Elégie 150  
(P 2750)

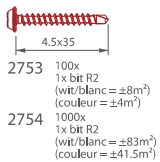

Potdexsel 167  
Clin 167  
structuré  
(P 1036)

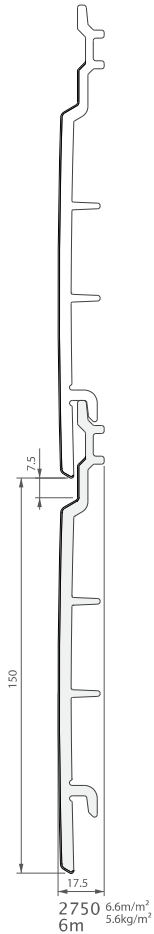
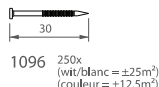
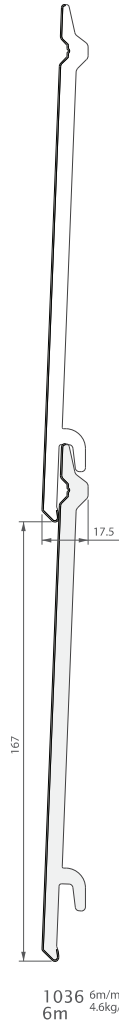

Dubbele rabat  
300  
Double clin  
structuré  
300  
(P 1024)

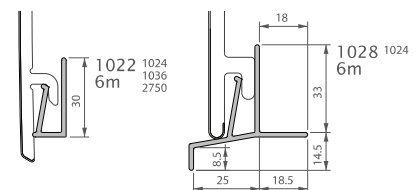
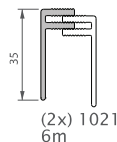
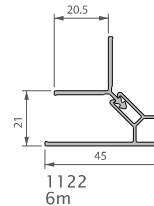
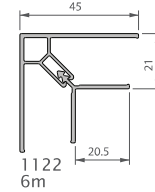
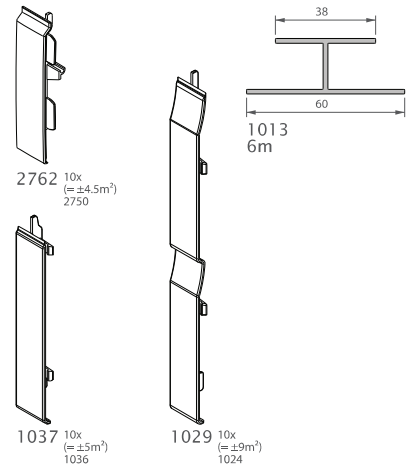
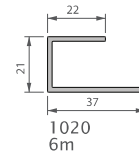
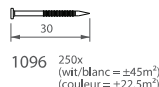
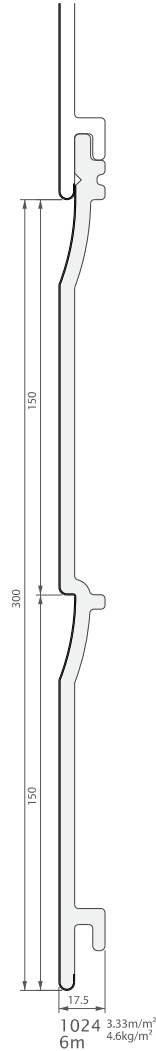

P	# / m <sup>2</sup>		P	# / m <sup>2</sup>		P	# / m <sup>2</sup>	
2750	6.6m <sup>2</sup> /m <sup>2</sup>	5.6kg/m <sup>2</sup>	1036	6m <sup>2</sup> /m <sup>2</sup>	4.6kg/m <sup>2</sup>	1036	3.33m <sup>2</sup> /m <sup>2</sup>	4.6kg/m <sup>2</sup>
2753	± 12 / m <sup>2</sup>		1096	± 10 / m <sup>2</sup>		1096	± 6 / m <sup>2</sup>	
2754	(003/wit/blanc)			(003/wit/blanc)			(003/wit/blanc)	
	± 24 / m <sup>2</sup>			± 20 / m <sup>2</sup>			± 12 / m <sup>2</sup>	
	(kleur/couleur)			(kleur/couleur)			(kleur/couleur)	
2762	± 2.2 / m <sup>2</sup>	5.6kg/m <sup>2</sup>	1037	± 2 / m <sup>2</sup>	4.6kg/m <sup>2</sup>	1029	± 1.1 / m <sup>2</sup>	4.6kg/m <sup>2</sup>

B-05/14-84803-8123 Alle gegevens zijn ter goede trouw en waar mogelijk onze huidige kennis. Zij kunnen dimalle niet tegen ons gebuikt worden. / Toutes les informations données reflètent l'état de nos connaissances et peuvent en aucun cas être reçues comme nous. Veuillez nous tenir informés.

Standard

Dak & gevel / Bardage & sous-toitures



Deceuninck nv - Benelux

Bruggesteeweg 360 - B-8830 Hooglede-Gits

(BE) T + 32 51 239 272 - F + 32 51 239 261 - belux@deceuninck.com - www.deceuninck.be

(NL) T + 31 76 561 78 34 - F + 31 76 75 02 353 - deceuninck.kunststof@deceuninck.com - www.deceuninck.nl

Building a sustainable home