

Holle terrasplanken Planches alvéolaires

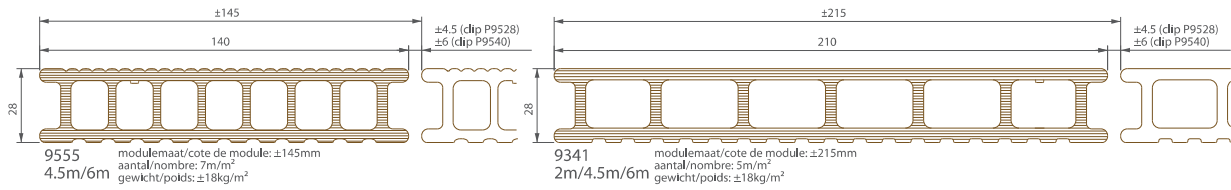

Aluminium onderstructuur Sous-structure en aluminium

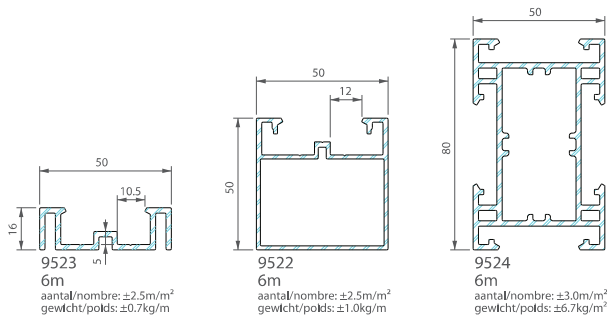

HOEKVERBINDER VOOR P9524 RACCORD MECANIQUE POUR P9524

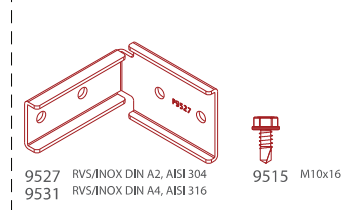

9495 10x 9527 RVS/INOX DIN A2, AISI 304
40x 9515

9496 10x 9531 RVS/INOX DIN A4, AISI 316
40x 9515
±2m²

KOPPELING VOOR VAKWERK P9524 ACCOUPEMENT POUR CADRE P9524

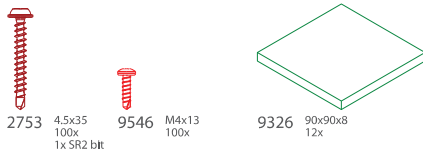
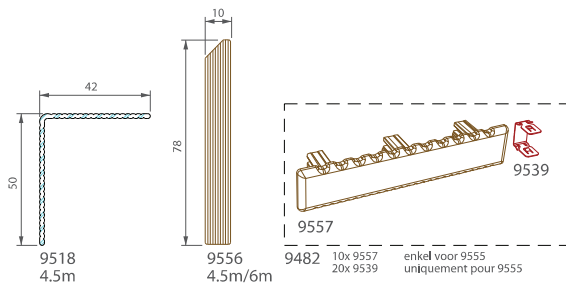
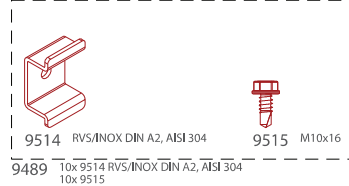

STARTCLIP CLIP DE DEPART	STANDAARD MONTAGECLIP CLIP DE MONTAGE STANDARD	EINDCLIP CLIP DE FINITION
9512 RVS/INOX DIN A4, AISI 316 10x	9486 85x 9528 9555: ±6.5m ² 100x 9546 9341: ±7.5m ² 1x bit PH2	9512 RVS/INOX DIN A4, AISI 316 10x

Houten onderstructuur of onderstructuur met P 9552 Sous-structure en bois ou P 9552

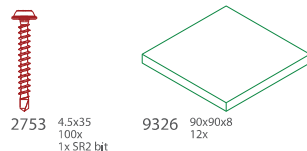
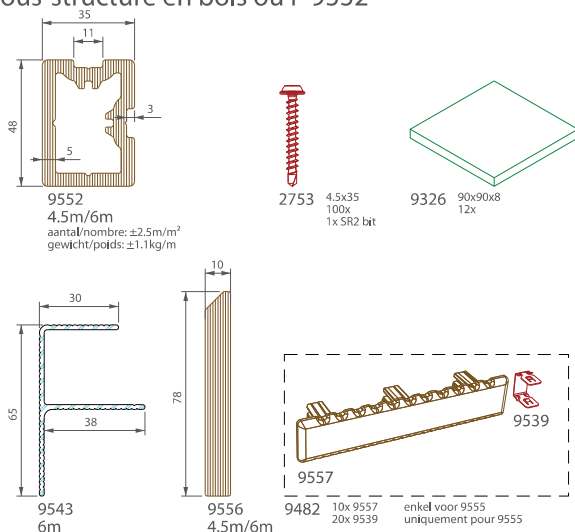

STARTPROFIEL PROFIE DE DEPART	STANDAARD MONTAGECLIP CLIP DE MONTAGE STANDARD	EINDCLIP CLIP DE FINITION
2761 3m	9540 9538 4x35	9529 RVS/INOX DIN A4, AISI 316 4.5x25
9542 4.5x25 110x	9483 100x 9540 9555: ±6.5m ² 120x 9538 9341: ±9.0m ² 1x bit SR1	9481 10x 9529 10x 9542
	9484 600x 9540 720x 9538 9341: ±54.5m ² 1x bit SR1	